

# PIN CONNECTOR [MLC-xP-3-x]

Cable Products, Hardline Connectors

## Features

- Pin Connector Housing Adapter
- 500 or 540 Pin Type
- 3 Piece Design
- Connector Type 5/8 (KS)
- P1, P3, or QR Cable Type
- Standard Quantity: 10 pcs



## Ordering Information

MLC - **x** P - 3 - **x**

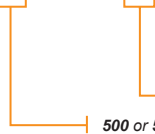

P1, P3 or QR (540 Pin Type Only) Cable Type

500 or 540 Pin Type

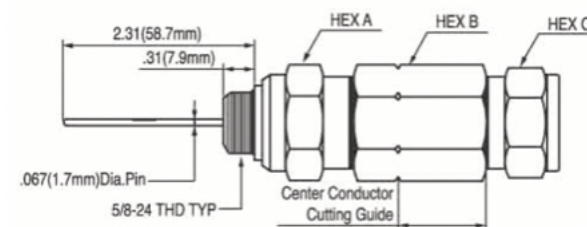

## 3 Piece Pin Connector

MLC-500P-3-P1	.500 Pin Connector, 3 Piece, P1 Cable
MLC-500P-3-P3	.500 Pin Connector, 3 Piece, P3 Cable
MLC-540P-3-QR	.540 Pin Connector, 3 Piece, QR Cable

# SPLICE CONNECTOR [MLC-xS-3-x]

Cable Products, Hardline Connectors

## Features

- Cable to Cable Splice
- 500 or 540 Pin Type
- 3 Piece Design
- P1, P3, or QR Cable Type
- Standard Quantity: 10 pcs

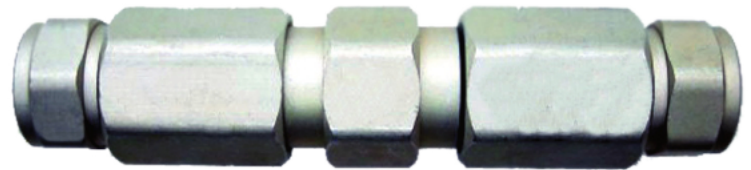

## Ordering Information

MLC - **x** S - 3 - **x**

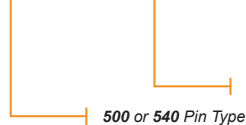

P1, P3 or QR (540 Pin Type Only) Cable Type

500 or 540 Pin Type

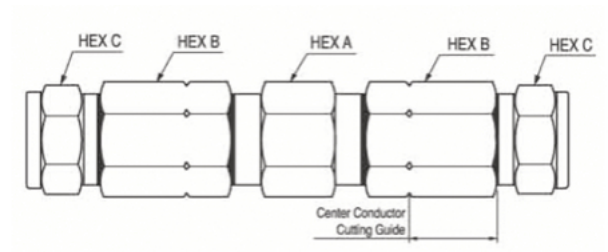

## 3 Piece Splice Connector

MLC-500S-3-P1	.500 Splice Connector, 3 Piece, P1 Cable
MLC-500S-3-P3	.500 Splice Connector, 3 Piece, P3 Cable
MLC-540S-3-QR	.540 Splice Connector, 3 Piece, QR Cable

# 90° & 180° ADAPTERS [MLC-x]

Cable Products, Hardline Connectors

## Features

- 90° & 180° Degree Adapter
- Connector Type 5/8 (KS)
- Standard Quantity: 10 pcs

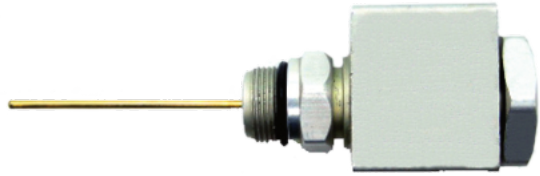

### 90° Adapter

MLC-90	90° Adapter, 1.0"
--------	-------------------

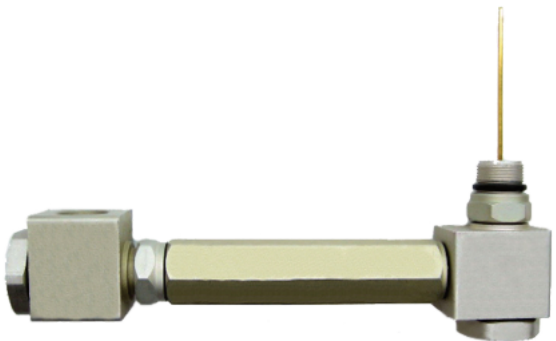
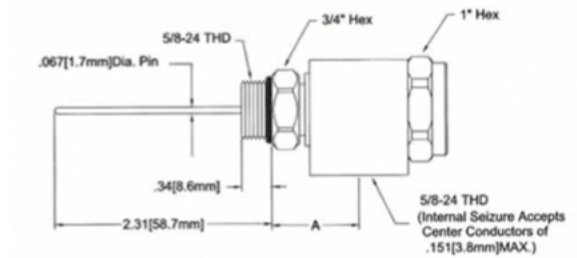

### 180° Adapter

MLC-180	180° Adapter
---------	--------------

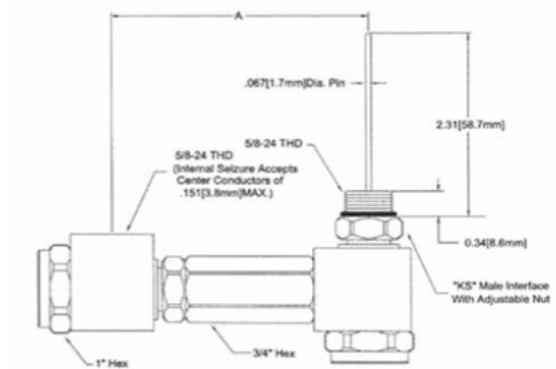

## Ordering Information

MLC - X

90° or 180° Adapter

# ADDITIONAL ADAPTERS [MLC-x]

Cable Products, Hardline Connectors

## MLC-FTC-x: Feed through Connector

- Standard Quantity: 10 pcs

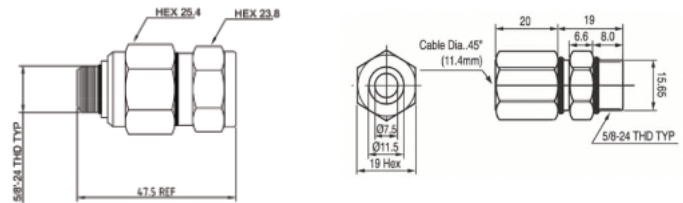

## MLC-F: Connector to F Port

- Standard Quantity: 10 pcs

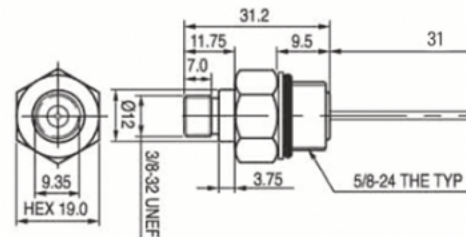

## MLC-HH-R: Housing to Housing Connector

- Standard Quantity: 10 pcs

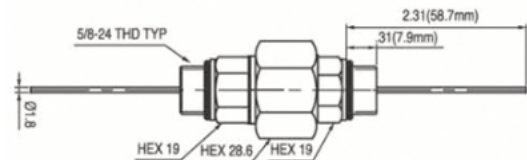

## MLC-500F: F to Female/Male Connector

- Standard Quantity: 10 pcs

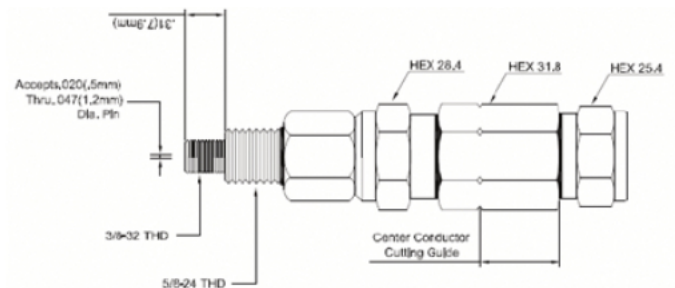

## MLC-TRM: 75 Ohm Housing Terminator

- Standard Quantity: 10 pcs

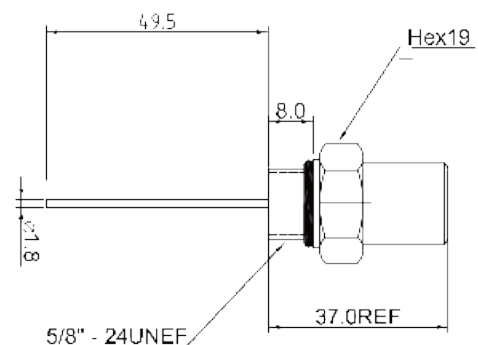

## Ordering Information

